

## SDS0603K SERIES ~ High Current Power Inductors



### PART NUMBERING SYSTEM

<b>SEP</b>	<b>0603K</b>	—	<b>R68M</b>	—	<b>LF</b>
TYPE	DIMENSIONS		INDUCTANCE		LEAD FREE

### FEATURES :

- Low profile ( 3.00mm max. height ) and 7.3 mm max. square.
- Magnetically shielded and low DC resistance .
- Suitable for large current .
- Ideal for DC – DC converter inductor application in hand help personal Computer ,etc .
- Frequency range up to 5MHZ .
- Large current handling capability .

### SHAPES AND DIMENSIONS :

UNIT : mm

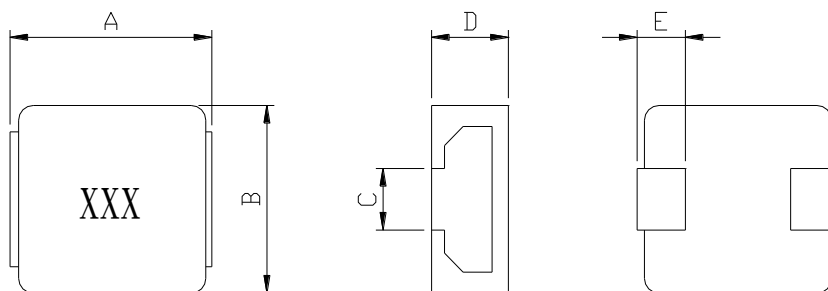

A=7.3 Max. B=6.67 Max. C=1.27±0.3 D=3.0 Max. E=3.0±0.3

### RECOMMENDED PATTERNS

UNIT : mm

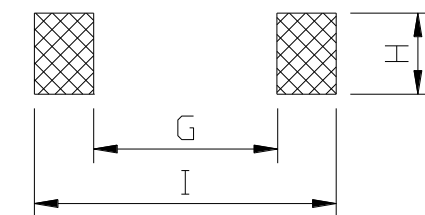

H=3.5 G= 3.8 I = 7.4



## SDS0603K SERIES ~ High Current Power Inductors



### SPECIFICATION TABLE

PART NUMBER	INDUCTANCE ( $\mu$ H)	Isat ( A ) (Typ.)	Irms ( A ) (Typ.)	DCR (m $\Omega$ ) (Typ.)	TEST FREQ. ( f )
SEP0603K-R47M-LF	0.47 $\pm$ 20%	19.0	15.0	3.40	100KHz/0.1V
SEP0603K-R68M-LF	0.68 $\pm$ 20%	22.0	13.0	4.70	100KHz/0.1V
SEP0603K-R82M-LF	0.82 $\pm$ 20%	18.0	10.5	6.60	100KHz/0.1V
SEP0603K-1R0M-LF	1.0 $\pm$ 20%	17.5	9.5	7.10	100KHz/0.1V
SEP0603K-1R5M-LF	1.5 $\pm$ 20%	16.0	9.0	10.7	100KHz/0.1V
SEP0603K-2R2M-LF	2.2 $\pm$ 20%	14.0	8.0	13.9	100KHz/0.1V
SEP0603K-3R3M-LF	3.3 $\pm$ 20%	11.0	6.0	28.0	100KHz/0.1V
SEP0603K-4R7M-LF	4.7 $\pm$ 20%	7.5	5.0	38.8	100KHz/0.1V
SEP0603K-6R8M-LF	6.8 $\pm$ 20%	6.5	4.5	48.9	100KHz/0.1V
SEP0603K-8R2M-LF	8.2 $\pm$ 20%	6.0	4.0	55.9	100KHz/0.1V
SEP0603K-100M-LF	10 $\pm$ 20%	5.0	3.5	64.0	100KHz/0.1V

- Isat : DC current at which the inductance drops 20% (typ) from its value without current.
- I rms : Average current for a 40°C temperature rise above 25°C ambient.
- Operating temperature range -55°C to +125°C , Electrical specifications at 25°C.

### PACKAGING SPECIFICATION

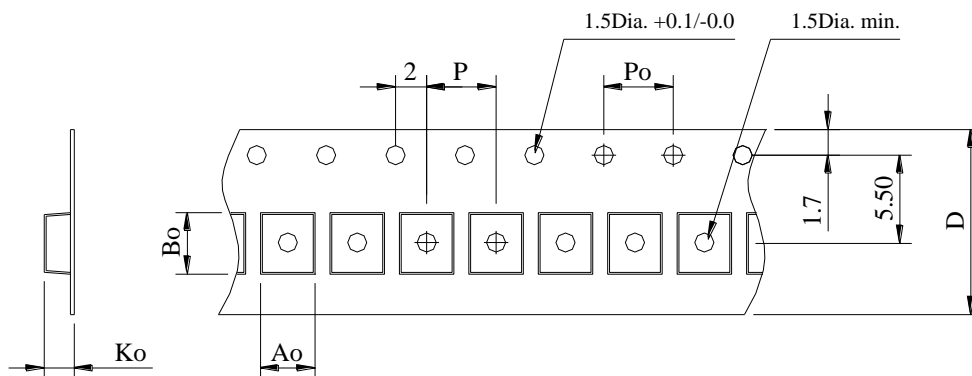

STAYLE	Q'TY (PCS)	DIMENSIONS (m/m)					
		Ao	Bo	Ko	P	Po	D $\pm$ 0.3
13"	1,000	7.2	7.0	3.4	12	4.0	16



## SDS0603K SERIES ~ High Current Power Inductors



### Inductance vs DC Current ( Isat )

**SEP0603K-R20M-LF**

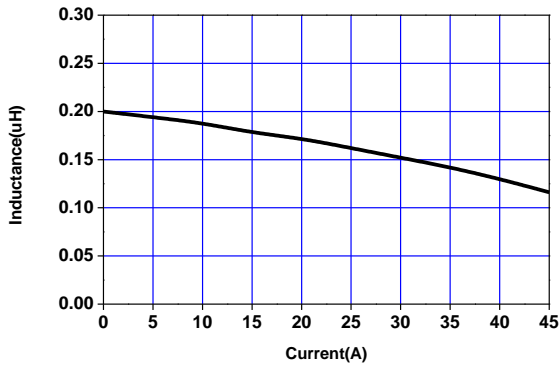

**SEP0603K-R47M-LF**

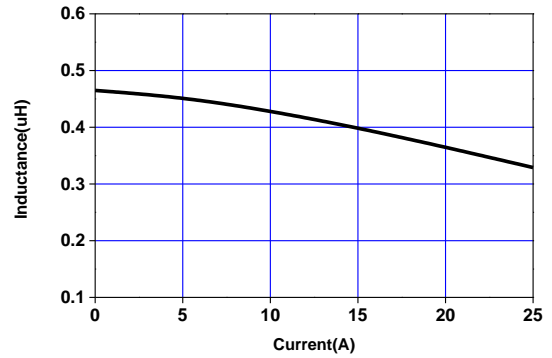

**SEP0603K-R68M-LF**

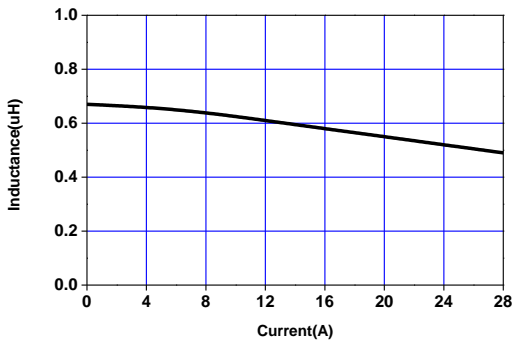

**SEP0603K-R82M-LF**

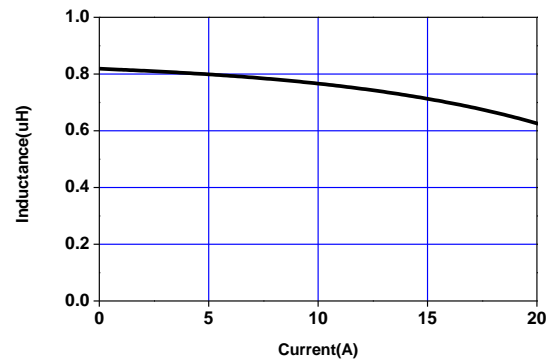

**SEP0603K-1R0M-LF**

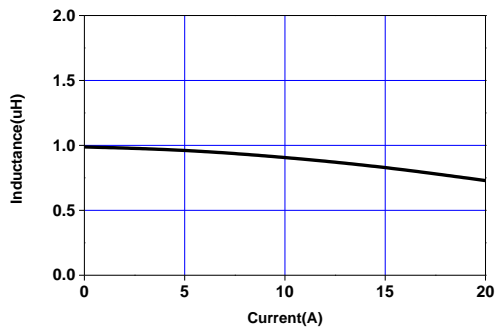

**SEP0603K-1R5M-LF**

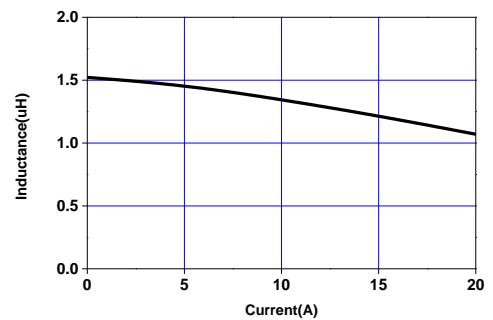



## SDS0603K SERIES ~ High Current Power Inductors



### Inductance vs DC Current ( Isat )

**SEP0603K-2R2M-LF**

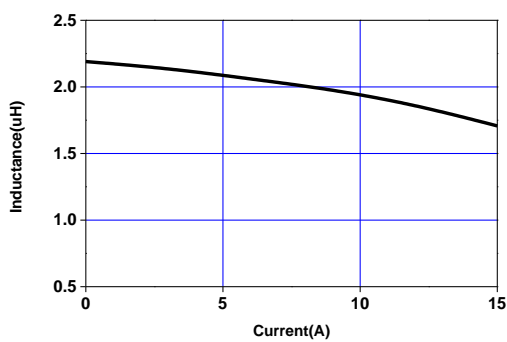

**SEP0603K-3R3M-LF**

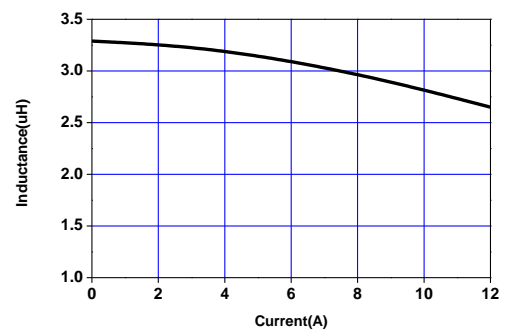

**SEP0603K-4R7M-LF**

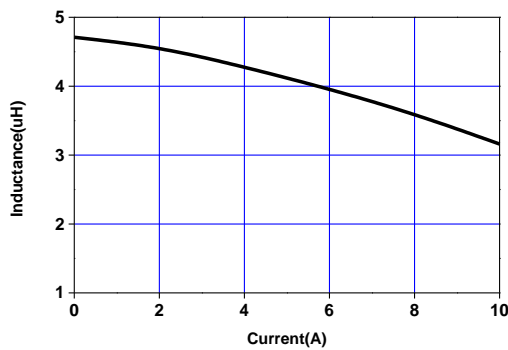

**SEP0603K-6R8M-LF**

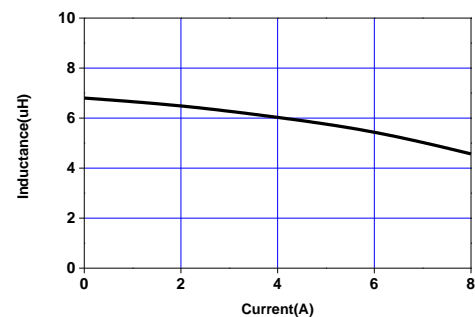

**SEP0603K-8R2M-LF**

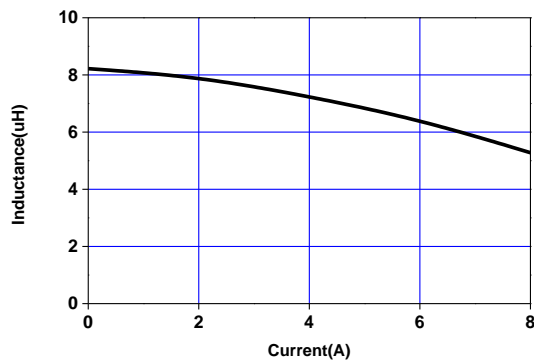

**SEP0603K-100M-LF**

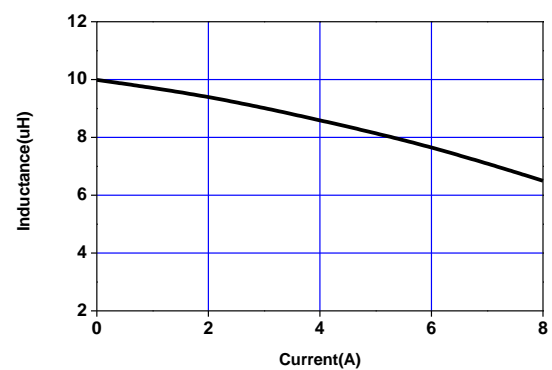



## SDS0603K SERIES ~ High Current Power Inductors



### Temperature rise vs Current ( Irms )

**SEP0603K-R20M-LF**

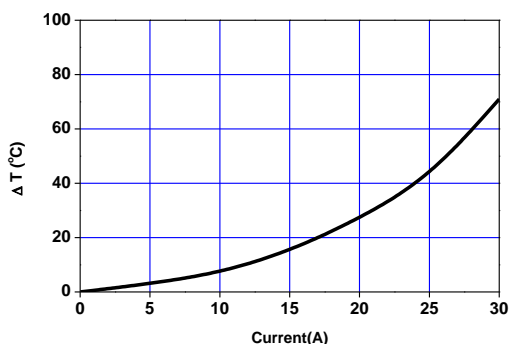

**SEP0603K-R47M-LF**

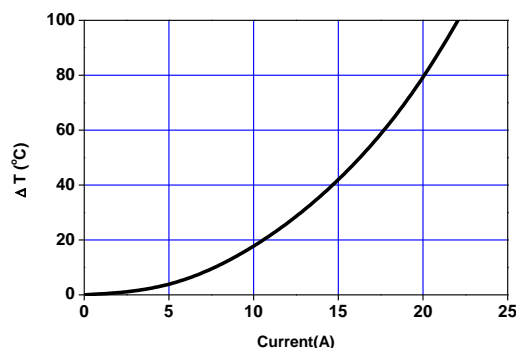

**SEP0603K-R68M-LF**

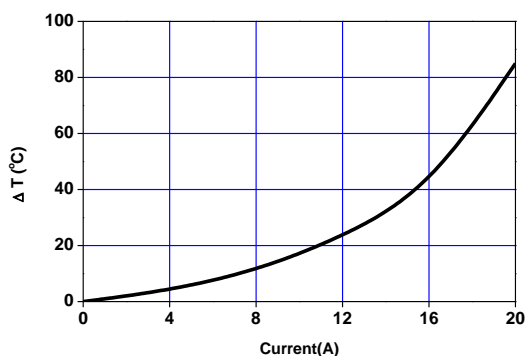

**SEP0603K-R82M-LF**

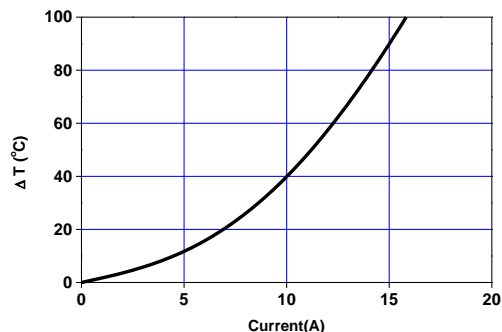

**SEP0603K-1R0M-LF**

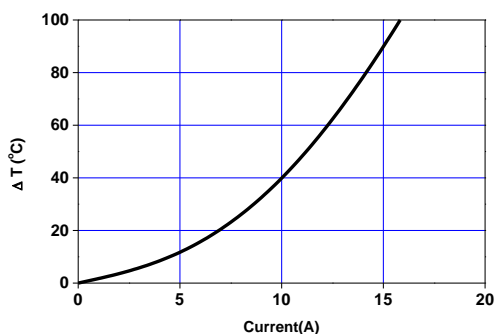

**SEP0603K-1R5M-LF**

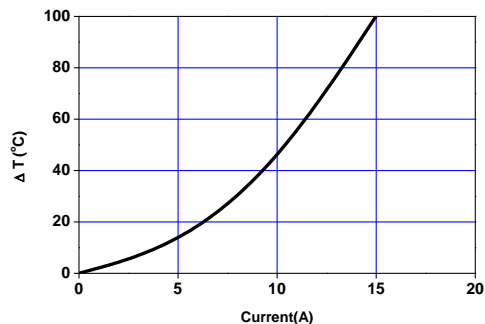



## SDS0603K SERIES ~ High Current Power Inductors



### Inductance vs DC Current ( Isat )

**SEP0603K-2R2M-LF**

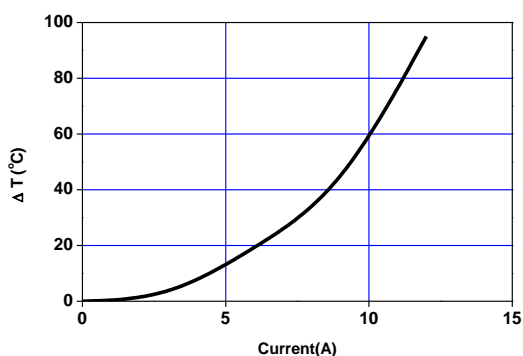

**SEP0603K-3R3M-LF**

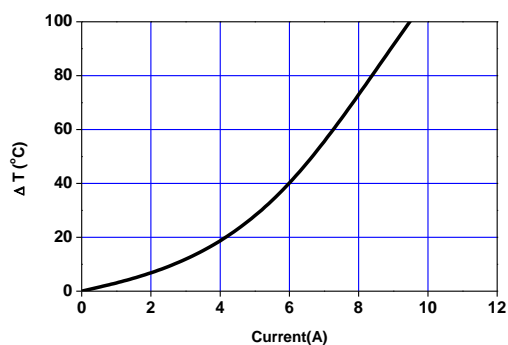

**SEP0603K-4R7M-LF**

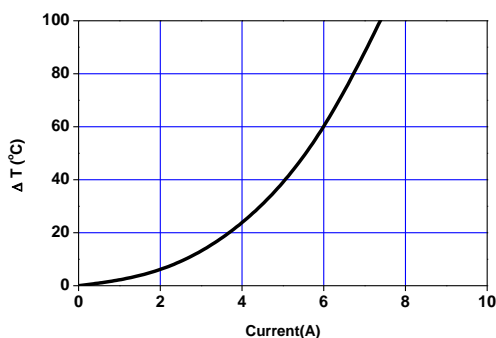

**SEP0603K-6R8M-LF**

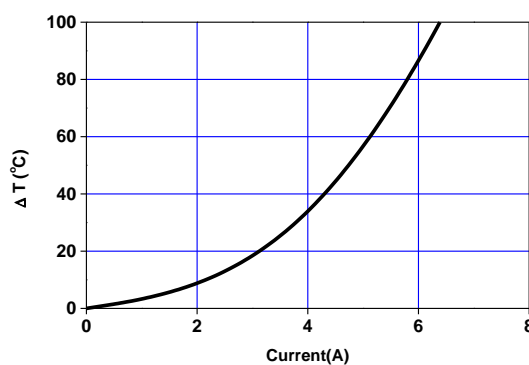

**SEP0603K-8R2M-LF**

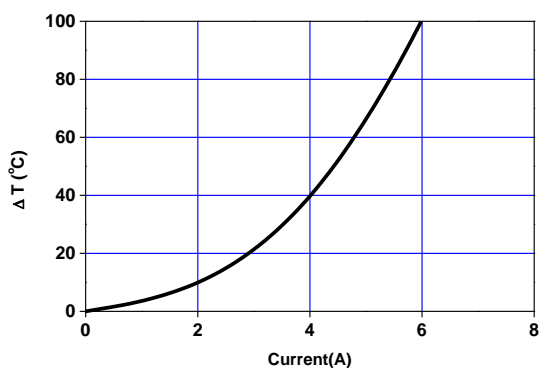

**SEP0603K-100M-LF**

